



Forma, materia, funzione,  
tecnologia.  
Ampio spazio alla ricerca formale.  
Non più semplici corpi scaldanti ma  
veri e propri elementi d'arredo.

Form, material, function,  
technology.  
Extensive space for formal research.  
No longer simply heating structures  
but true items of furniture.

Forme, matière, fonction,  
technologie.  
Ample espace dédié à la  
recherche des formes.  
Pas de simples corps chauffants  
mais de vrais objets pour intérieurs.



Forma, materia, función,  
tecnología.  
Ampio espacio a la  
investigación formal.  
Ya no simples cuerpos de  
calentamiento, sino verdaderos  
elementos decorativos.



# dress

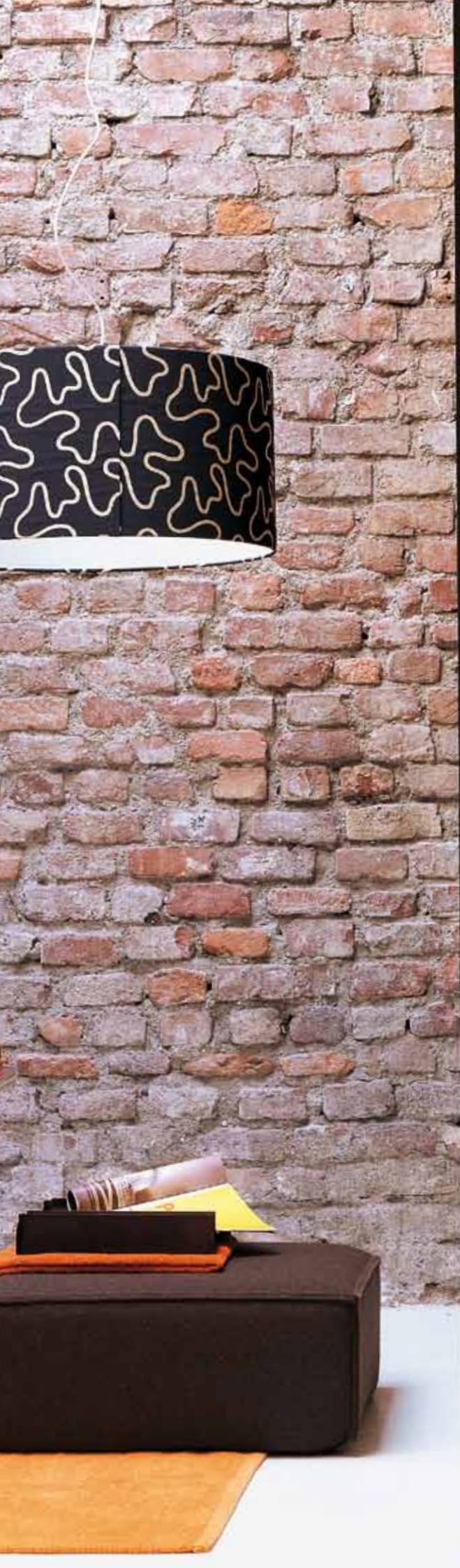

# DRESS ORIZZONTALE

design: Franca Lucarelli - Bruna Rapisarda

## MATERIALE:

- acciaio e lastra in vetro temprato colorato
- acciaio e lastra specchio inox lucido

## IL PREZZO COMPRENDE:

- radiatore completo di vetro o specchio inox
- staffe a parete
- valvola e detentore
- valvola di sfriato

## FINITURE

- spalle radiatore:
  - lucido
- lastra vetro temprato:
  - bianco
  - nero
  - arancio
  - rosso
  - acquamarina
- lastra specchio:
  - inox lucido

## VERSIONE ELETTRICA

- disponibile

## VERSIONE MISTA

- disponibile

## MONTAGGIO A BANDIERA

- non previsto

## NOTE TECNICHE

- valvola, detentore e attacchi idraulici interni al radiatore, mascherati dalla lastra
- pressione massima di esercizio: 6 bar
- non disponibile per impianti monotubo

## MATERIAL:

- steel and hardened, stained glass sheet
- steel and polished, stainless mirror sheet

## THE PRICE INCLUDES:

- radiator complete with glass and stainless mirror
- wall brackets
- valve and holder
- exhaust valve

## FINISH

- radiator supports:
  - polished
- hardened glass sheet:
  - white
  - black
  - orange
  - red
  - aquamarine
- mirror sheet:
  - polished, stainless

## ELECTRIC VERSION

- available

## DUAL ENERGY VERSION

- available

## SIDE WALL INSTALLATION

- not envisaged

## TECHNICAL NOTES

- valve, holder and hydraulic joints inside the radiator, hidden by the sheet
- maximum working pressure: 6 bar
- not available for single tube installation

## MATÉRIAU:

- acier et plaque en verre de sécurité coloré
- acier et plaque miroir en acier inox brillant

## LE PRIX COMPREND:

- radiateur équipé de glace ou miroir inox
- supports muraux
- soupape et détendeur
- soupape de décompression

## FINITIONS

- épaules radiateur:
  - polies
- plaque de verre de sécurité:
  - blanc
  - noir
  - orange
  - rouge
  - aigue-marine
- plaque miroir:
  - inox brillant

## VERSION ÉLECTRIQUE

- disponible, page 129

## VERSION MIXTE

- disponible, page 128

## MONTAGE AVEC PAROI LATÉRALE

- non prévu

## NOTES TECHNIQUES

- soupape, détendeur, raccords hydrauliques à l'intérieur du radiateur, cachés par la plaque
- pression maximale de service: 6 bars
- non disponible pour installations monotube

## MATERIAL:

- acero y plancha de vidrio templado coloreado
- acero y plancha espejo de acero inoxidable brillante

## EL PRECIO COMPRENDE:

- radiador con vidrio o espejo de acero inoxidable
- soportes de pared
- válvula y llave de cierre
- purgador

## ACABADOS

- laterales radiador:
  - brillante
- plancha vidrio templado:
  - blanco
  - negro
  - naranja
  - rojo
  - aguamarina
- plancha espejo:
  - acero inoxidable brillante

## VERSIÓN ELÉCTRICA

- disponible

## VERSIÓN MIXTA

- disponible

## MONTAJE CON PARED LATERAL

- no previsto

## NOTAS TÉCNICAS

- válvula, llave de cierre y conexiones hidráulicas en el interior del radiador, camufladas por la plancha
- presión máxima de trabajo: 6 bares
- no disponible para instalaciones monotubo

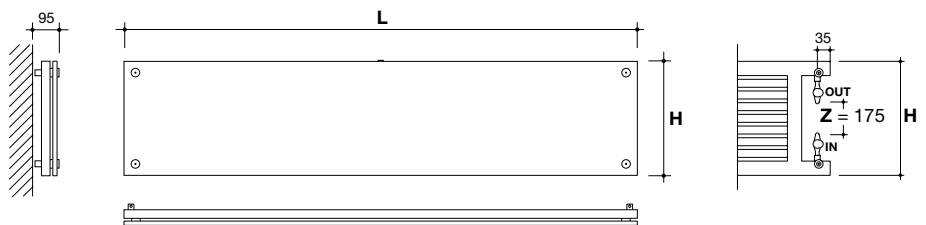
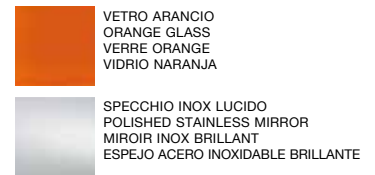
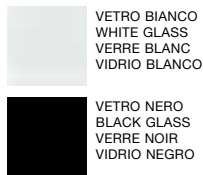

## RESE TERMICHE THERMAL OUTPUT

## UNI EN 442 (ΔT 50 K)

| ART.             | DIMENSIONI<br>Dimensions<br>mm. |     |     | RESA<br>Output<br>W | CAPACITÀ<br>Capacity<br>Lt | PESO<br>Weight<br>kg | RESISTENZA<br>Resistance<br>Watt | LASTRA DI COPERTURA<br>Cover sheet |
|------------------|---------------------------------|-----|-----|---------------------|----------------------------|----------------------|----------------------------------|------------------------------------|
|                  | L                               | H   | Z   |                     |                            |                      |                                  |                                    |
| DRESS<br>18X40 V | 1800                            | 400 | 175 | 680                 | 10,2                       | 29,5                 | 600                              | Vetro<br>Glass                     |
| DRESS<br>18X40 S | 1800                            | 400 | 175 | 850                 | 10,2                       | 31,5                 | 600                              | Inox<br>Stainless                  |

SPECIFICARE NELL'ORDINE  
Materiale e diametro  
del tubo di collegamento

PLEASE SPECIFY IN THE ORDER  
Material and diameter  
of the connection pipe

SPECIFIER DANS L'ORDRE  
Matériau et diamètre  
du tube de raccordement

ESPECIFICAR EN EL PEDIDO  
Material y diámetro  
del tubo de conexión



▣ | Dress

# DRESS VERTICALE design: Franca Lucarelli - Bruna Rapisarda

## MATERIALE:

- acciaio e lastra in vetro temprato colorato
- acciaio e lastra specchio inox lucido

## IL PREZZO COMPRENDE:

- radiatore completo di vetro o specchio inox
- staffe a parete
- valvola e detentore
- valvola di sfogo

## FINITURE

- spalle radiatore:
  - lucido
- lastra vetro temprato:
  - bianco
  - nero
  - arancio
  - rosso
  - acquamarina
- lastra specchio:
  - inox lucido

## VERSIONE ELETTRICA

- disponibile

## VERSIONE MISTA

- disponibile

## MONTAGGIO A BANDIERA

- non previsto

## NOTE TECNICHE

- valvola, detentore e attacchi idraulici interni al radiatore, mascherati dalla lastra
- pressione massima di esercizio: 6 bar
- non disponibile per impianti monotubo

## MATERIAL:

- steel and hardened, stained glass sheet
- steel and polished, stainless mirror sheet

## THE PRICE INCLUDES:

- radiator complete with glass and stainless mirror
- wall brackets
- valve and holder
- exhaust valve

## FINISH

- radiator supports:
  - polished
- hardened glass sheet:
  - white
  - black
  - orange
  - red
  - aquamarine
- mirror sheet:
  - polished, stainless

## ELECTRIC VERSION

- available

## DUAL ENERGY VERSION

- available

## SIDE WALL INSTALLATION

- not envisaged

## TECHNICAL NOTES

- Valve, holder and hydraulic joints inside the radiator, hidden by the sheet
- maximum working pressure: 6 bar
- not available for single tube installation

## MATÉRIAU:

- acier et plaque en verre de sécurité coloré
- Acier et plaque miroir en acier inox brillant

## LE PRIX COMPREND:

- radiateur équipé de glace ou miroir inox
- supports muraux
- soupape et détendeur
- soupape de décompression

## FINITIONS

- épaules radiateur:
  - polies
- plaque de verre de sécurité:
  - blanc
  - noir
  - orange
  - rouge
  - aigue-marine
- plaque miroir:
  - inox brillant

## VERSION ÉLECTRIQUE

- disponible, page 129

## VERSION MIXTE

- disponible, page 128

## MONTAGE AVEC PAROI LATÉRALE

- non prévu

## NOTES TECHNIQUES

- soupape, détendeur, raccords hydrauliques à l'intérieur du radiateur, cachés par la plaque
- pression maximale de service: 6 bars
- non disponible pour installations monotube

## MATERIAL:

- acero y plancha de vidrio templado coloreado
- acero y plancha espejo de acero inoxidable brillante

## EL PRECIO COMPRENDE:

- radiador con vidrio o espejo de acero inoxidable
- soportes de pared
- válvula y llave de cierre
- purgador

## ACABADOS

- laterales radiador:
  - brillante
- plancha vidrio templado:
  - blanco
  - negro
  - naranja
  - rojo
  - aguamarina
- plancha espejo:
  - acero inoxidable brillante

## VERSIÓN ELÉCTRICA

- disponible

## VERSIÓN MIXTA

- disponible

## MONTAJE CON PARED LATERAL

- no previsto

## NOTAS TÉCNICAS

- Válvula, llave de cierre y conexiones hidráulicas en el interior del radiador, camufladas por la plancha
- presión máxima de trabajo: 6 bares
- no disponible para instalaciones monotubo



### ACCESSORI - ACCESSORIES ACCESSOIRES - ACCESORIOS

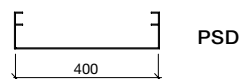

### PORTA ASCIUGAMANO Towel holder - Porte-serviettes - Toallero

- Finitura: cromo
- Finish: chrome
- Finition: chrome
- Acabado: cromo

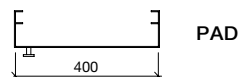

### PORTA ACCAPPATOIO Robe holder - Portemanteau - Porta-albornoz

- Finitura: cromo
- Finish: chrome
- Finition: chrome
- Acabado: cromo

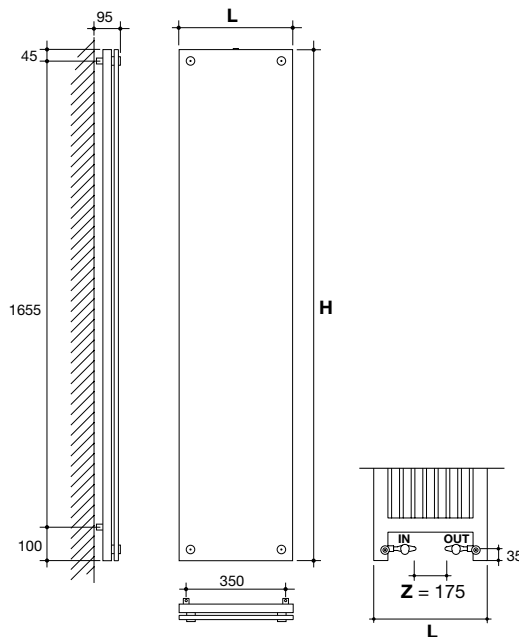

|  |   |
|--|---|
|  | VETRO BIANCO<br>WHITE GLASS<br>VERRE BLANC<br>VIDRIO BLANCO   |
|  | VETRO NERO<br>BLACK GLASS<br>VERRE NOIR<br>VIDRIO NEGRO   |
|  | VETRO ACQUAMARINA<br>AQUAMARINE GLASS<br>VERRE AIGUE-MARINE<br>VIDRIO AGUAMARINA                                  |
|  | VETRO ROSSO<br>RED GLASS<br>VERRE ROUGE<br>VIDRIO ROJO  |
|  | VETRO ARANCIO<br>ORANGE GLASS<br>VERRE ORANGE<br>VIDRIO NARANJA   |
|  | SPECCHIO INOX LUCIDO<br>POLISHED STAINLESS MIRROR<br>MIROIR INOX BRILLANT<br>ESPEJO ACERO INOXIDABLE<br>BRILLANTE |

### RESE TERMICHE THERMAL OUTPUT

### UNI EN 442 (ΔT 50 K)

| ART.             | DIMENSIONI<br>Dimensions<br>mm. |      |     | RESA<br>Output<br>W | CAPACITÀ<br>Capacity<br>Lt | PESO<br>Weight<br>kg | RESISTENZA<br>Resistance<br>Watt | LASTRA DI COPERTURA<br>Cover sheet |
|------------------|---------------------------------|------|-----|---------------------|----------------------------|----------------------|----------------------------------|------------------------------------|
|                  | L                               | H    | Z   |                     |                            |                      |                                  |                                    |
| DRESS<br>18X40 V | 400                             | 1800 | 175 | 680                 | 10,2                       | 29,5                 | 600                              | Vetro<br>Glass                     |
| DRESS<br>18X40 S | 400                             | 1800 | 175 | 850                 | 10,2                       | 31,5                 | 600                              | Inox<br>Stainless                  |

SPECIFICARE NELL'ORDINE  
Materiale e diametro  
del tubo di collegamento

PLEASE SPECIFY IN THE ORDER  
Material and diameter  
of the connection pipe

SPECIFIER DANS L'ORDRE  
Matériau et diamètre  
du tube de raccordement

ESPECIFICAR EN EL PEDIDO  
Material y diámetro  
del tubo de conexión



◆ | Dress